

# JVC

## SERVICE MANUAL

### COLOUR TELEVISION

# AV28L2EUGR AV28L2EUBL AV28L2EUGY

BASIC CHASSIS

MF

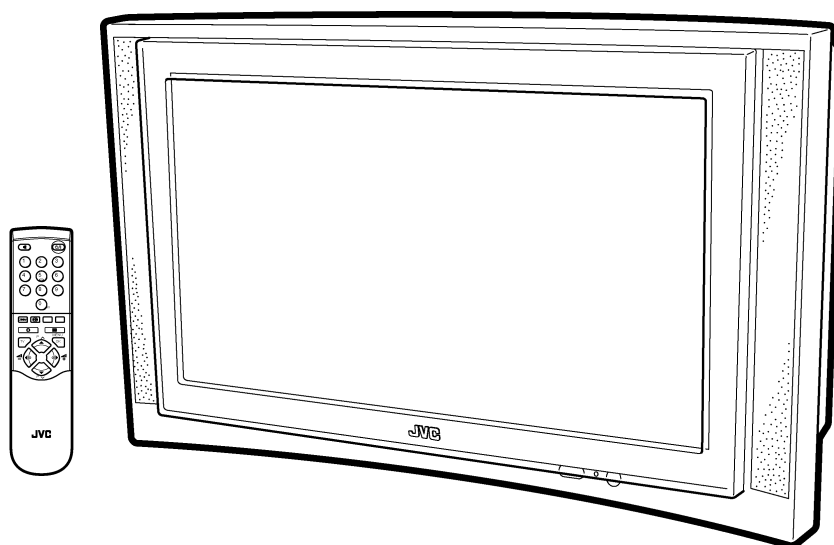

## CONTENTS

■ SPECIFICATIONS .....	2
■ SAFETY PRECAUTIONS .....	4
■ FEATURES .....	5
■ MAIN DIFFERENCE LIST .....	5
■ SPECIFIC SERVICE INSTRUCTIONS .....	6
■ SERVICE ADJUSTMENTS .....	12
■ PARTS LIST .....	31
★ OPERATING INSTRUCTIONS	
★ STANDARD CIRCUIT DIAGRAM .....	2-1

# SPECIFICATIONS

Item	Content
<b>Dimensions ( W × H × D )</b>	800mm × 500mm × 498mm
<b>Mass</b>	41.0kg
<b>TV RF System</b>	CCIR ( B/G, D/K, L, L', I )
<b>Colour System</b>	PAL / SECAM / NTSC (Only in EXT mode)
<b>Stereo System</b>	A2 (B/G, D/K) / NICAM (B/G, I, D/K, L)
<b>Teletext System</b>	Fastext (UK system) / TOP (German system) WST(Standard system)
<b>Receiving Frequency</b>	<b>VHF</b> 47MHz ~ 470MHz <b>UHF</b> 470MHz ~ 862MHz • French cable TV channel of broadcast frequencies 116~172MHz & 220~469MHz
<b>Intermediate Frequency</b>	<b>VIF Carrier</b> 38.9MHz (B/G, D/K, I, L) / 33.95MHz (L') <b>SIF Carrier</b> 33.4MHz (5.5MHz : B/G) 32.9MHz (6.0MHz : I) / 32.4MHz (6.5MHz : L, D/K) / 40.45MHz (6.5MHz : L')
<b>Colour Sub Carrier Freq.</b>	<b>PAL</b> 4.43MHz <b>SECAM</b> 4.40625MHz / 4.25MHz <b>NTSC</b> 3.58MHz / 4.43MHz
<b>Power Input</b>	AC 220V ~ 240V , 50Hz
<b>Power Consumption</b>	183W(Max) / 127W(Avg).
<b>Aerial Input Term</b>	75Ω unbalanced, Coaxial
<b>Picture Tube</b>	Visible size : 66cm, Measured diagonally
<b>High Voltage</b>	+1.0kV 31.0kV -1.5kV (at zero beam current)
<b>Speaker</b>	20cm × 4cm, Oval type × 2 with BOX
<b>Audio Output</b>	7.5W + 7.5W
<b>EXT-1/EXT-2/EXT-3 (IN/OUT)</b>	21-pin Euro connector (SCART socket) × 3
<b>EXT-4 (Input)</b>	<b>Video</b> 1Vp-p 75Ω (RCA pin jack) <b>Audio(L/R)</b> 500mVrms(-4dBs), High Impedance (RCA pin jack) <b>S / Video</b> Y : 1Vp-p POSITIVE (Negative sync Provided, when terminated with 75Ω) C : 0.3Vp-p (Burst signal, when terminated with 75Ω)
<b>AUDIO OUT (Variable)</b>	0~1Vrms, Low Impedance (RCA pin jack × 2)
<b>Headphone jack</b>	Stereo mini jack ( ϕ 3.5mm )
<b>Remote Control Unit</b>	RM-C54 (AAA/R03 dry cell battery × 2)

*Design & specifications are subject to change without notice.*

## ■ 21-pin Euro connector (SCART socket) : EXT-1 / EXT-2 / EXT-3

(P-P= Peak to Peak, B-W= Blanking to white peak)

Pin No.	Signal Designation	Matching Value	EXT-1	EXT-2	EXT-3
1	AUDIO R output	500mVrms(Nominal), Low impedance	○ (TV OUT)	○ (LINE OUT)	NC
2	AUDIO R input	500mVrms(Nominal), High impedance	○	○	○
3	AUDIO L output	500mVrms(Nominal), Low impedance	○ (TV OUT)	○ (LINE OUT)	NC
4	AUDIO GND		○	○	○
5	GND (B)		○	○	○
6	AUDIO L input	500mVrms(Nominal), High impedance	○	○	○
7	B input	700mV <sub>B-W</sub> , 75Ω	○	○	NC
8	FUNCTION SW (SLOW SW)	Low : 0-3V, High : 8-12V, High impedance	○	○	○
9	GND (G)		○	○	○
10	SCL3		NC	○	NC
11	G input	700mV <sub>B-W</sub> , 75Ω	○	○	NC
12	SDA3		NC	○	NC
13	GND (R)		○	○	○
14	GND (Y <sub>S</sub> )		○	○	NC
15	R / C input	R : 700mV <sub>B-W</sub> , 75Ω C : 300mV <sub>P-P</sub> , 75Ω	○ (only R)	○	○ (only C)
16	Ys input	Low : 0 - 0.4, High : 1 - 3V, 75Ω	○	○	NC
17	GND(VIDEO output)		○	○	○
18	GND(VIDEO input)		○	○	○
19	VIDEO output	1V <sub>P-P</sub> (Negative going sync), 75Ω	○ (TV)	○ (LINE OUT)	NC
20	VIDEO / Y input	1V <sub>P-P</sub> (Negative going sync), 75Ω	○	○	○
21	COMMON GND		○	○	○

[Pin assignment]

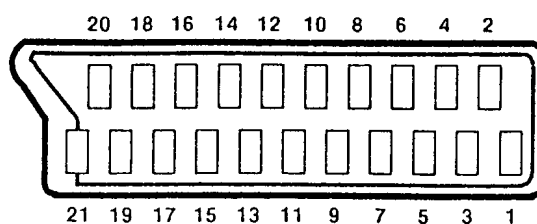

# SAFETY PRECAUTIONS

1. The design of this product contains special hardware, many circuits and components specially for safety purposes. For continued protection, no changes should be made to the original design unless authorized in writing by the manufacturer. Replacement parts must be identical to those used in the original circuits. Service should be performed by qualified personnel only.
2. Alterations of the design or circuitry of the products should not be made. Any design alterations or additions will void the manufacturer's warranty and will further relieve the manufacturer of responsibility for personal injury or property damage resulting therefrom.
3. Many electrical and mechanical parts in the products have special safety-related characteristics. These characteristics are often not evident from visual inspection nor can the protection afforded by them necessarily be obtained by using replacement components rated for higher voltage, wattage, etc. Replacement parts which have these special safety characteristics are identified in the parts list of Service manual. **Electrical components having such features are identified by shading on the schematics and by ( $\Delta$ ) on the parts list in Service manual.** The use of a substitute replacement which does not have the same safety characteristics as the recommended replacement part shown in the parts list of Service manual may cause shock, fire, or other hazards.
4. **Don't short between the LIVE side ground and ISOLATED (NEUTRAL) side ground or EARTH side ground when repairing.**  
Some model's power circuit is partly different in the GND. The difference of the GND is shown by the LIVE : ( $\perp$ ) side GND, the ISOLATED(NEUTRAL) : ( $\text{⏏}$ ) side GND and EARTH : ( $\oplus$ ) side GND. Don't short between the LIVE side GND and ISOLATED(NEUTRAL) side GND or EARTH side GND and never measure with a measuring apparatus (oscilloscope etc.) the LIVE side GND and ISOLATED(NEUTRAL) side GND or EARTH side GND at the same time.  
If above note will not be kept, a fuse or any parts will be broken.
5. If any repair has been made to the chassis, it is recommended that the B1 setting should be checked or adjusted (See ADJUSTMENT OF B1 POWER SUPPLY).
6. The high voltage applied to the picture tube must conform with that specified in Service manual. Excessive high voltage can cause an increase in X-Ray emission, arcing and possible component damage, therefore operation under excessive high voltage conditions should be kept to a minimum, or should be prevented. If severe arcing occurs, remove the AC power immediately and determine the cause by visual inspection (incorrect installation, cracked or melted high voltage harness, poor soldering, etc.). To maintain the proper minimum level of soft X-Ray emission, components in the high voltage circuitry including the picture tube must be the exact replacements or alternatives approved by the manufacturer of the complete product.
7. Do not check high voltage by drawing an arc. Use a high voltage meter or a high voltage probe with a VTVM. Discharge the picture tube before attempting meter connection, by connecting a clip lead to the ground frame and connecting the other end of the lead through a 10k $\Omega$  2W resistor to the anode button.
8. When service is required, observe the original lead dress. Extra precaution should be given to assure correct lead dress in the high voltage circuit area. Where a short circuit has occurred, those components that indicate evidence of overheating should be replaced. Always use the manufacturer's replacement components.

## 9. Isolation Check

### (Safety for Electrical Shock Hazard)

After re-assembling the product, always perform an isolation check on the exposed metal parts of the cabinet (antenna terminals, video/audio input and output terminals, Control knobs, metal cabinet, screwheads, earphone jack, control shafts, etc.) to be sure the product is safe to operate without danger of electrical shock.

#### (1) Dielectric Strength Test

The isolation between the AC primary circuit and all metal parts exposed to the user, particularly any exposed metal part having a return path to the chassis should withstand a voltage of 3000V AC (r.m.s.) for a period of one second.

(. . . Withstand a voltage of 1100V AC (r.m.s.) to an appliance rated up to 120V, and 3000V AC (r.m.s.) to an appliance rated 200V or more, for a period of one second.)

This method of test requires a test equipment not generally found in the service trade.

#### (2) Leakage Current Check

Plug the AC line cord directly into the AC outlet (do not use a line isolation transformer during this check.). Using a "Leakage Current Tester", measure the leakage current from each exposed metal part of the cabinet, particularly any exposed metal part having a return path to the chassis, to a known good earth ground (water pipe, etc.). Any leakage current must not exceed 0.5mA AC (r.m.s.).

However, in tropical area, this must not exceed 0.2mA AC (r.m.s.).

#### ● Alternate Check Method

Plug the AC line cord directly into the AC outlet (do not use a line isolation transformer during this check.). Use an AC voltmeter having 1000 ohms per volt or more sensitivity in the following manner. Connect a 1500 $\Omega$  10W resistor paralleled by a 0.15 $\mu$ F AC-type capacitor between an exposed metal part and a known good earth ground (water pipe, etc.). Measure the AC voltage across the resistor with the AC voltmeter. Move the resistor connection to each exposed metal part, particularly any exposed metal part having a return path to the chassis, and measure the AC voltage across the resistor. Now, reverse the plug in the AC outlet and repeat each measurement. Any voltage measured must not exceed 0.75V AC (r.m.s.). This corresponds to 0.5mA AC (r.m.s.).

However, in tropical area, this must not exceed 0.3V AC (r.m.s.). This corresponds to 0.2mA AC (r.m.s.).

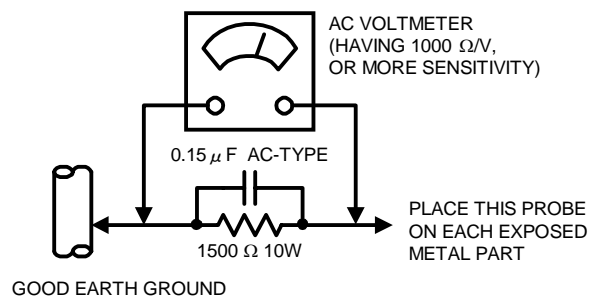

# FEATURES

- New chassis design enable use of an interactive on screen control.
- The TELETEXT SYSTEM has a built-in FASTEXT (UK system), TOP (German system) and WST (world standard system) system.
- Pure FLAT CRT reproduce fine textured.
- Digi Pure pro : Auto digi pure with motion picture compensation.
- Because this TV unit corresponds to multiplex broadcast, users can enjoy music programs and sporting events with live realism. In addition, BILINGUAL programs can be heard in their original language.
- Built-in ECO (ECONOMY, ECOLOGY) MODE.  
 In accordance with the brightness in a room, the brightness and/or contrast of the picture can be adjusted automatically to make the optimum picture which is easy on the eye.
- Users can make VCR dubbing of picture and sound by controlling the AV selector to select an optional source at the EXT-2 output shown in figure.

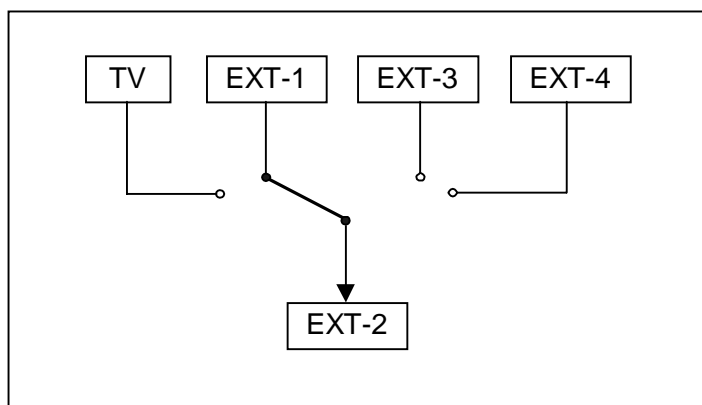

# MAIN DIFFERENCE LIST

△	Model name	AV28L2EUGR	AV28L2EUBL	AV28L2EUGY
	Part name			
△	FRONT FRAME	LC11007-001B-U	LC11007-002B-U	LC11007-003A-U
△	RATING LABEL	LC20380-008A-U LC20379-008A-U	LC20380-012A-U LC20379-012A-U	LC20380-023A-U LC20379-019A-U
	EURO LABEL	AEM1052-017-E	AEM1052-014-E	AEM1052-071-E

# SPECIFIC SERVICE INSTRUCTIONS

## DISASSEMBLY PROCEDURE

### REMOVING THE REAR COVER

1. Unplug the power cord.
2. Remove the 11 screws marked "A" as shown in the Fig. 1.
3. Withdraw the rear cover toward you.

### REMOVING THE SIDE CONTROL JACK ASSEMBLY

- After removing the rear cover.
1. Remove the screw marked B as shown in the Fig.1.
  2. While slightly raise the side control jack assembly, remove the 2 claws under the side control jack assembly.
  3. Disconnect the connector "SR", "SL", "S", "F" and "K" as shown in Fig 2.

### REMOVING THE SIDE CONTROL PWB

- After removing the rear cover and side control jack assembly.
1. Remove the 3 claws "C" from back side of the side control jack assembly as shown in Fig.2.
  2. Pull out the SIDE CONTROL PWB.

### REMOVING THE CHASSIS

- After removing the rear cover.
1. Slightly raise the both sides of the chassis by hand and remove the two claws under the both sides of the chassis from the front cabinet.
  2. Withdraw the chassis backward.  
(If necessary, take off the wire clamp, connectors etc.)

### REMOVING THE SPEAKER BOX

- After removing the rear cover.
1. Remove the 2 screws marked "D" as shown in Fig. 1.
- NOTE :** When removing the screws marked D of the speaker box assembly, remove the lower side screw first, and then remove the upper one.
2. Remove the 2 screws "E" attaching the speaker box.
  3. Remove the 2 screws "F" attaching the speaker.
  4. Follow the same steps when removing the other hand speaker.

### REMOVING THE AV TERMINAL BOARD

- After removing the rear cover.
1. Remove the 3 screws marked "G" as shown in the Fig. 1.
  2. Remove the 2 claws marked "H" under the CHASSIS as shown in Fig. 3.
  3. Remove the AV TERMINAL BOARD slightly in the direction of arrow "I" as shown in Fig. 3.

### CHECKING THE PW BOARD

To check the back side of the PW Board.

- 1) Pull out the chassis. (Refer to REMOVING THE CHASSIS).
- 2) Erect the chassis vertically so that you can easily check the back side of the PW Board.

#### [CAUTION]

- When erecting the chassis, be careful so that there will be no contacting with other PW Board.
- Before turning on power, make sure that the wire connector is properly connected.
- When conducting a check with power supplied, be sure to confirm that the CRT EARTH WIRE (BRAIDED ASS'Y) is connected to the CRT SOCKET PW board.

### WIRE CLAMPING AND CABLE TYING

1. Be sure to clamp the wire.
2. Never remove the cable tie used for tying the wires together.  
Should it be inadvertently removed, be sure to tie the wires with a new cable tie.

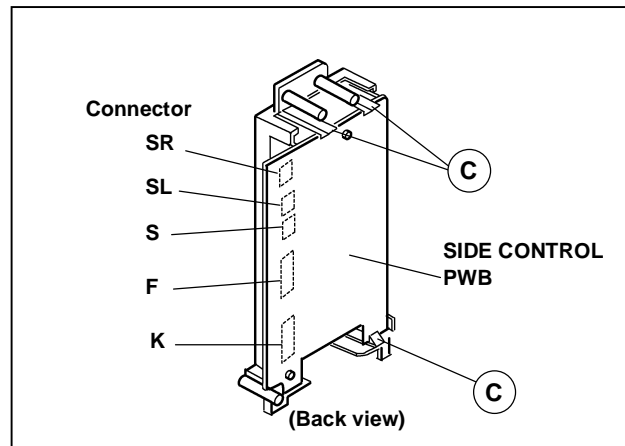

Fig. 2

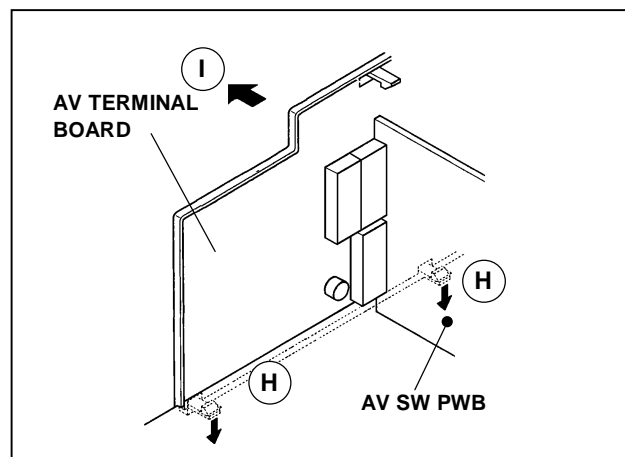
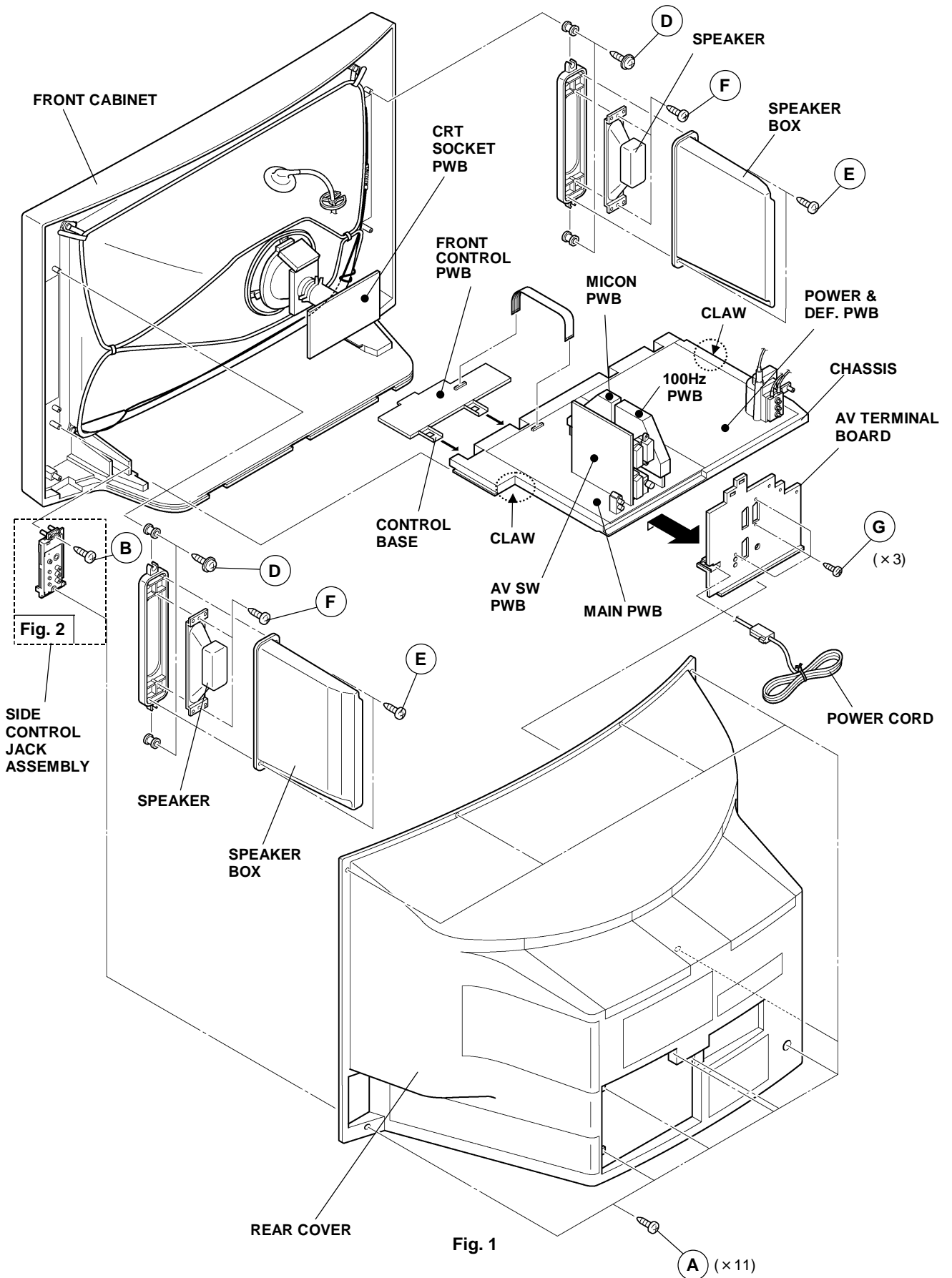

Fig. 3



## REMOVING THE CRT

- \* Replacement of the CRT should be performed by 2 or more persons.
- After removing the cover, chassis etc.,
- 1. Putting the CRT change table on soft cloth, the CRT change table should also be covered with such soft cloth (shown in Fig.4).
- 2. While keeping the surface of CRT down, mount the TV set on the CRT change table balanced will as shown in Fig.5.
- 3. Remove 4 screws marked by arrows with a box type screw driver as shown in Fig.5.
- Since the cabinet will drop when screws have been removed, be sure to support the cabinet with hands.
- 4. After 4 screws have been removed, put the cabinet slowly on cloth (At this time, be carefully so as not to damage the front surface of the cabinet) shown in Fig.6.
- The CRT should be assembled according to the opposite sequence of its dismounting steps.
- \* The CRT change table should preferably be smaller than the CRT surface, and its height be about 35cm.
- \* About CRT Spacer  
 An appropriate CRT spacer should be used in the corresponding CRT in accordance with the type of the CRT.  
 When a CRT is replaced, special attention should be paid to this matter.

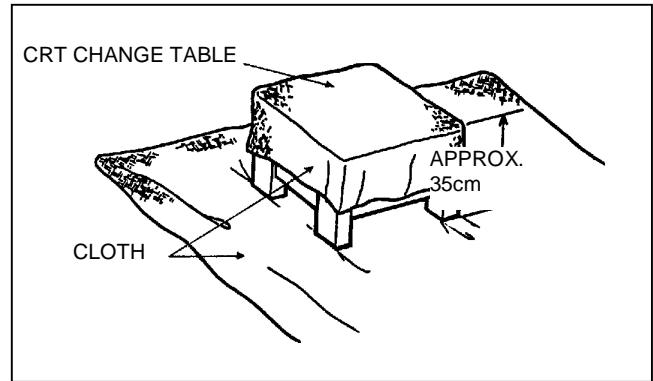

Fig. 4

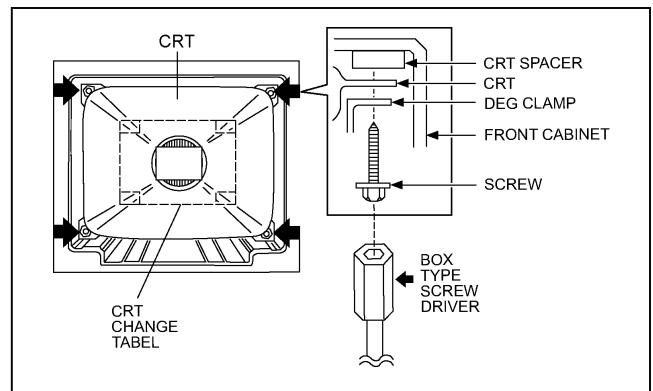

Fig. 5

## COATING OF SILICON GREASE FOR ELECTRICAL INSULATION ON THE CRT ANODE CAP SECTION.

- Subsequent to replacement of the CRT and HV transformer or repair of the anode cap, etc. by dismounting them, be sure to coat silicon grease for electrical insulation as shown in Fig.7. Wipe around the anode button with clean and dry cloth. (Fig.7) Coat silicon grease on the section around the anode button. At this time, take care so that any silicon greases dose not stick to the anode button. (Fig.8)

★ Silicon grease product No. KS - 650N

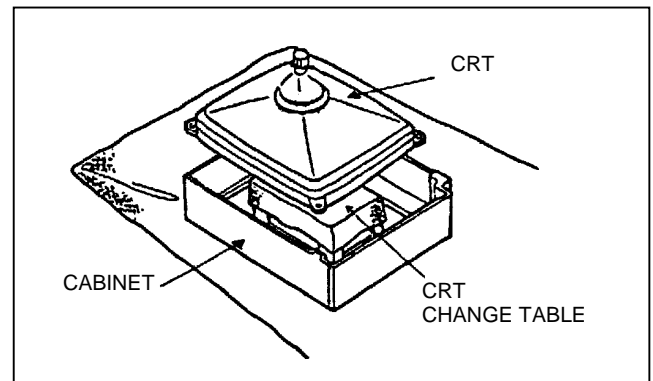

Fig. 6

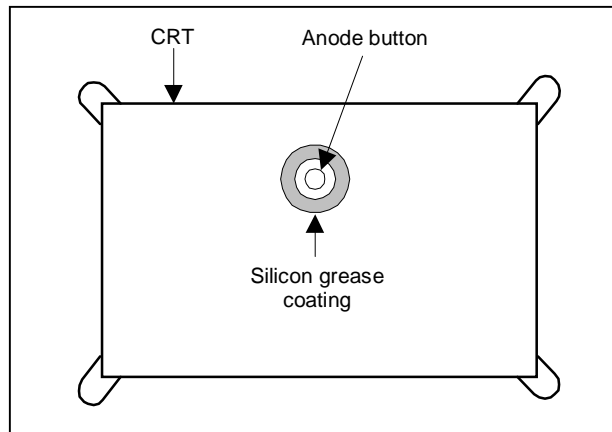

Fig. 7

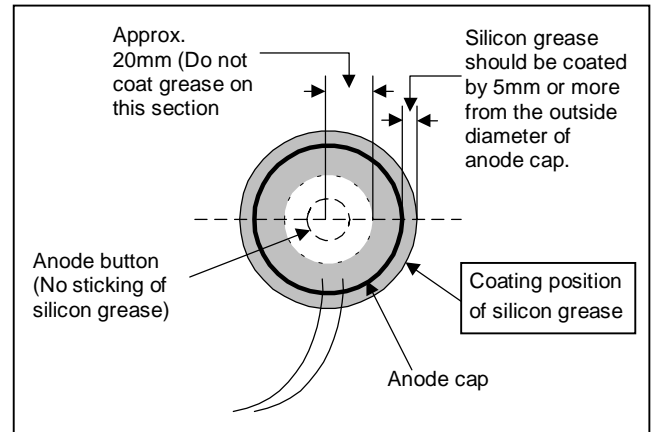

Fig. 8



## REPLACEMENT OF MEMORY ICs

### 1. Memory ICs

This TV use memory ICs. In the memory ICs, there are memorized data for correctly operating the video and deflection circuits. When replacing memory ICs, be sure to use ICs written with the initial values of data.

### 2. Procedure for replacing memory ICs

PROCEDURE
<p>(1) <b>Power off</b> Switch the power off and unplug the power cord from the wall outlet.</p>
<p>(2) <b>Replace ICs.</b> Be sure to use memory ICs written with the initial data values.</p>
<p>(3) <b>Power on</b> Plug the power cord into the wall outlet and switch the power on.</p>
<p>(4) <b>Check and set SYSTEM CONSTANT SET:</b></p> <ul style="list-style-type: none"> <li>* It must not adjust without signal.</li> <li>1) Press the INFORMATION key and the MUTING key of the REMOTE CONTROL UNIT simultaneously.</li> <li>2) The SERVICE MENU screen of Fig. 1 will be displayed.</li> <li>3) While the SERVICE MENU is displayed, press the INFORMATION key and MUTING key simultaneously, and the SYSTEM CONSTANT SET screen of Fig. 2 will be displayed.</li> <li>4) Check the setting values of the SYSTEM CONSTANT SET of Table 1. If the value is different, select the setting item with the FUNCTION UP/DOWN key, and set the correct value with the FUNCTION +/- key.</li> <li>5) Press the MENU(OK) key to memorize the setting value.</li> <li>6) Press the INFORMATION key, and return to the normal screen.</li> </ul>
<p>(5) <b>Setting of receive channels</b> Set the receive channel. For setting, refer to the OPERATING INSTRUCTIONS.</p>
<p>(6) <b>Setting of SERVICE MENU</b> Verify the setting items of the <b>SERVICE MENU</b> of Table 2, and reset where necessary. For setting, refer to the SERVICE ADJUSTMENTS.</p>
<p>(7) <b>User settings</b> Check the user setting values of Table 3, and if setting value is different, set the correct value. For setting, refer to the OPERATING INSTRUCTIONS.</p>

SERVICE MENU	
1. IF	2. V/C
3. AUDIO	4. DEF
5. VSM PRESET	6. STATUS
7. PIP	8. ---
9. SHIPPING (OFF)	0. BUS FREE
1-9 : SELECT    i : EXIT	

Fig.1







SYSTEM CONSTANT SET	
1. DESTINATION	EU
-/+  : STORE    i : EXIT	

Fig.2

2. CRT TYPE	16 : 9
3. PURITY	NO
4. PICTURE TILT	YES
5. DIGIPURE PRO	YES
6. PIP	NO
7. PIC & TEXT	YES
8. DOLBY	NO
9. BBE	YES
10. PROGRESSIVE	YES
11. TDA9178	YES
12. TONE IC	NO
13. FLAT	YES

#### NAME OF REMOTE CONTROL KEY

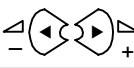
Names of key	key
INFORMATION	
MUTING	
MENU	
FUNCTION UP/DOWN	
FUNCTION +/-	
TV	

**SETTING VALUES OF SYSTEM CONSTANT SET (TABLE 1)**

Setting item	Setting content	Setting value
1. DESTINATION	<input type="checkbox"/> EK → <input checked="" type="checkbox"/> EU → <input type="checkbox"/> EI <input type="checkbox"/>	EU
2. CRT TYPE	<input type="checkbox"/> 16:9 → <input checked="" type="checkbox"/> 4:3 <input type="checkbox"/>	16:9
3. PURITY	<input type="checkbox"/> YES → <input checked="" type="checkbox"/> NO <input type="checkbox"/>	NO
4. PICTURE TILT	<input type="checkbox"/> YES → <input checked="" type="checkbox"/> NO <input type="checkbox"/>	YES
5. DIGIPURE PRO	<input type="checkbox"/> YES → <input checked="" type="checkbox"/> NO <input type="checkbox"/>	YES
6. PIP	<input type="checkbox"/> 1 TUNER → <input type="checkbox"/> 2 TUNER → <input checked="" type="checkbox"/> NO <input type="checkbox"/>	NO
7. PIC & TEXT	<input type="checkbox"/> YES → <input checked="" type="checkbox"/> NO <input type="checkbox"/>	YES
8. DOLBY	<input type="checkbox"/> YES → <input checked="" type="checkbox"/> NO <input type="checkbox"/>	NO
9. BBE	<input type="checkbox"/> YES → <input checked="" type="checkbox"/> NO <input type="checkbox"/>	YES
10. PROGRESSIVE	<input type="checkbox"/> YES → <input checked="" type="checkbox"/> NO <input type="checkbox"/>	YES
11. TDA9178	<input type="checkbox"/> YES → <input checked="" type="checkbox"/> NO <input type="checkbox"/>	YES
12. TONE IC	<input type="checkbox"/> YES → <input checked="" type="checkbox"/> NO <input type="checkbox"/>	NO
13. FLAT	<input type="checkbox"/> YES → <input checked="" type="checkbox"/> NO <input type="checkbox"/>	YES

**SERVICE MENU SETTING ITEMS (TABLE 2)**

Setting item	Setting value	Setting item	Setting value
1. IF	1. VCO	4. DEF.	1. V-SHIFT 2. V-SIZE 3. H-CENT 4. H-SIZE 5. TRAPEZ 6. EW-PIN 7. COR-PIN 8. COR-UP 9. COR-LO 10. ANGLE 11. BOW 12. V-S.CR 13. V.LIN
2. V / C	1. RGB BLK 2. WDR R 3. WDR G 4. WDR B 5. BRIGHT 6. CONTRAST 7. COLOUR 8. HUE 9. SHARP 10. VCO ADJUSTMENT 11. VIDEO AGC 12. SYNC SLICE		
3. AUDIO (Do not adjust)	1. ERR LIMIT 2. A2 ID THR	5. VSM PRESET <input type="checkbox"/> COOL <input checked="" type="checkbox"/> NORMAL <input type="checkbox"/> WARM	1. CONT. 2. BRIGHT 3. SHARP 4. COLOUR 5. HUE 6. WDR R 7. WDR G 8. WDR B
		6. STATUS (Do not adjust)	VPS PDC

**USER SETTING VALUES (TABLE 3)**

Setting item	Setting value	Setting item	Setting value
SUB POWER	ON	VOLUME	Appropriate sound volume
SHIPPING CHANNEL	PR1	DISPLAY	INDICATED
PRESET CHANNEL	See ; OPERATING INSTRUCTIONS.	ZOOM MODE	PANORAMIC
<b>PICTURE SETTING</b>		<b>EXT SETTING</b>	
TINT	COOL	ID	BLANK
CONTRAST	REFER to VSM SETTING	DUBBING	EXT-1→EXT-2
BRIGHT	REFER to VSM SETTING		
SHARP	REFER to VSM SETTING		
COLOUR	REFER to VSM SETTING		
ECO MODE	OFF		
<b>PICTURE FEATURES</b>		<b>FEATURES</b>	
DIGITAL VNR	AUTO	SLEEP TIMER	OFF
DIGIPURE PRO	AUTO	BLUE BLACK	ON
COLOUR SYSTEM	TV : According to preset CH	CHILD LOCK	ID : No.0000, ALL CH : OFF
AUTO ASPECT	EXT : AUTO	DECODER (EXT-2)	ALL CH : OFF
	PANORAMIC		
<b>SOUND SETTING</b>		<b>INSTALL</b>	
BASS	CENTER	LANGUAGE	ENGLISH
TREBLE	CENTER	EDIT	PR CHANNEL ONLY
BALANCE	CENTER		OTHERS : BLANK
TV SPEAKER	L / R		
HYPER SOUND	OFF		
BBE	ON		

# SERVICE ADJUSTMENTS

## BEFORE STARTING SERVICE ADJUSTMENT

1. There are 2 ways of adjusting this TV: One is with the REMOTE CONTROL UNIT and the other is the conventional method using adjustment parts and components.
2. The setting (adjustment) using the REMOTE CONTROL UNIT is made on the basis of the initial setting values. The setting values which adjust the screen to the optimum condition can be different from the initial setting values.
3. Make sure that connection is correctly made to AC power source.
4. Turn on the power of the TV and measuring instrument for warming up for at least 30 minutes before starting adjustment.
5. If the receive or input signal is not specified, use the most appropriate signal for adjustment.
6. Never touch parts (such as variable resistors, transformers and condensers) not shown in the adjustment items of this service adjustment.

7. Preparation for adjustment (presetting):

Unless otherwise specified in the adjustment items, preset the following functions with the REMOTE CONTROL UNIT:

- Setting position

PICTURE MODE (VSM)	NORMAL
SLEEP TIMER	OFF
BALANCE	CENTER
ECO	OFF
ZOOM	PANORAMIC

## MEASURING INSTRUMENT AND FIXTURES

1. DC voltmeter (or digital voltmeter)
2. Oscilloscope
3. Signal generator (Pattern generator) [PAL / SECAM / NTSC]
4. Remote control unit

## ADJUSTMENT ITEMS

- Checking items.
- Adjustment of FOCUS.
- VSM preset setting.
- VIDEO / CHROMA circuit adjustment.
- DEFLECTION circuit adjustment.
- AUDIO circuit adjustment. **(Do not adjust)**

# ADJUSTMENT LOCATIONS

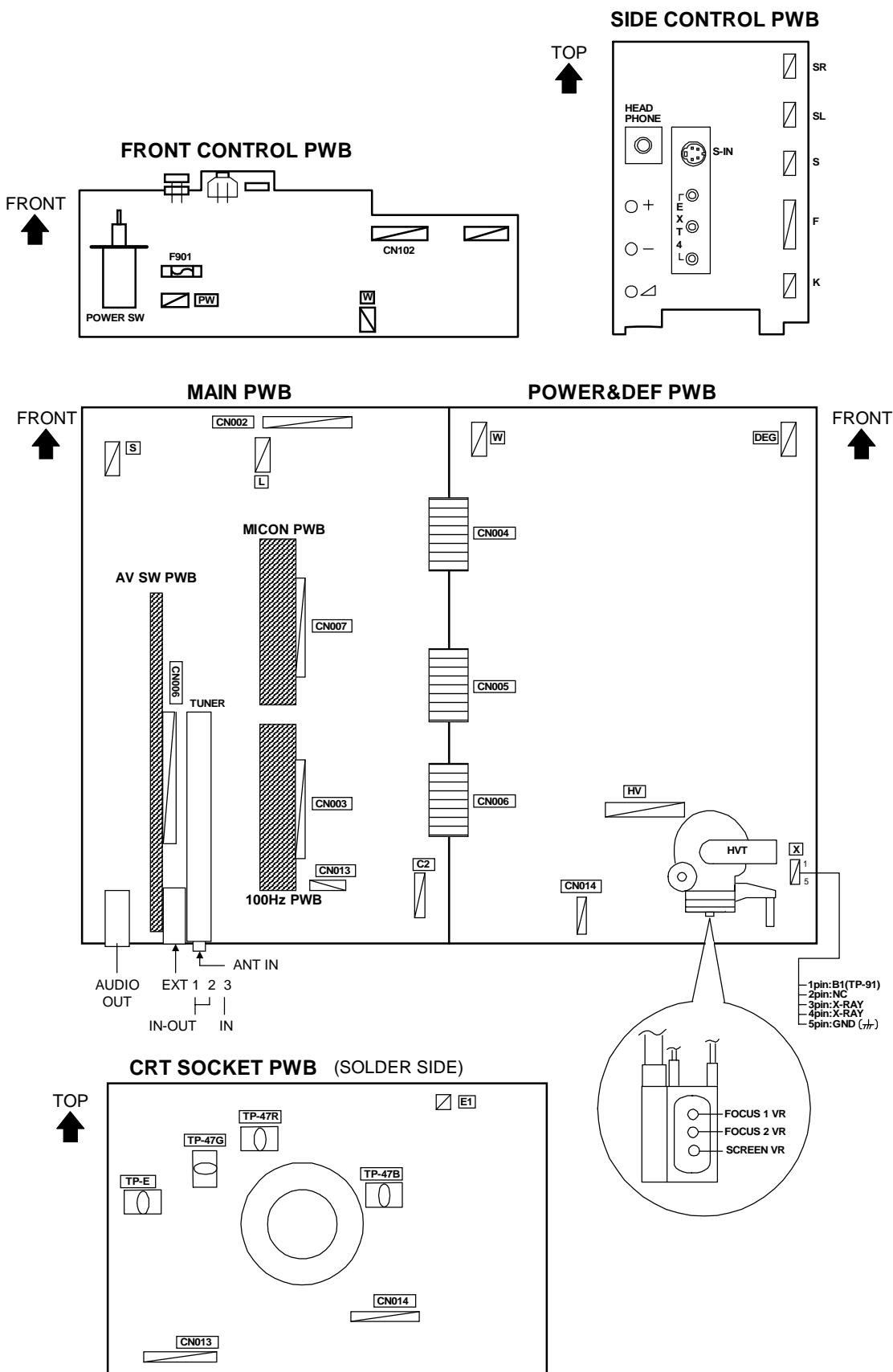

## BASIC OPERATION SERVICE MENU

### 1. TOOL OF SERVICE MENU OPERATION

Operate the SERVICE MENU with the REMOTE CONTROL UNIT.

### 2. SERVICE MENU ITEMS

With the SERVICE MENU, various settings (adjustments) can be made, and they are broadly classified in the following items of settings (adjustments):

- (1) **1. IF** ..... This mode adjusts the setting values of the IF circuit.
- (2) **2.V/C** ..... This mode adjusts the setting values of the VIDEO / CHROMA circuit.
- (3) **3.AUDIO** ..... This mode adjusts the setting values of the multiplicity SOUND circuit.
- (4) **4.DEF** ..... This mode adjusts the setting values of the DEFLECTION circuit for each aspect mode given below.

ASPECT	V. FREQ.
FULL	100Hz <sub>i</sub> / 60Hz <sub>P</sub> / 120Hz <sub>i</sub>
PANORAMIC	↑
SUBTITLE	↑

- (5) **5.VSM PRESET** ..... This mode adjusts the initial setting values of COOL,NOMAL and WARM.  
 (VSM : Video Status Memory)

### 3. BASIC OPERATION OF SERVICE MENU

#### (1) How to enter SERVICE MENU

Press the INFORMATION key and the MUTING key of the REMOTE CONTROL UNIT simultaneously, and the SERVICE MENU screen of Fig. 1 will be displayed.

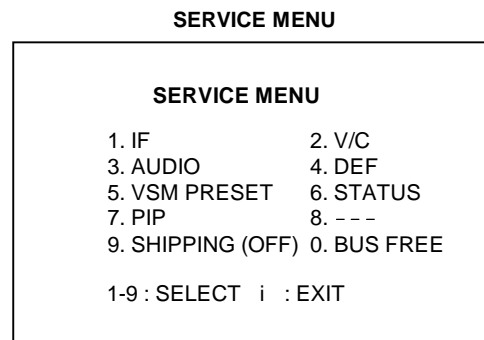

Fig.1

#### (2) Selection of SUB MENU SCREEN

Press one of keys 1~5 of the REMOTE CONTROL UNIT and select the SUB MENU SCREEN (See Fig. 3), form the SERVICE MENU.

SERVICE MENU → SUB MENU

- 1. IF
- 2. V / C
- 3. AUDIO
- 4. DEF.
- 5. VSM PRESET

- 6. STATUS
- 7. PIP
- 8. ---
- 9. SHIPPING (OFF)
- 0. BUSS FREE

DO NOT WORK

#### NAME OF REMOTE CONTROL KEY

Names of key	key
INFORMATION	
MUTING	
MENU	
FUNCTION UP/DOWN	
FUNCTION +/-	
TV	

Fig.2

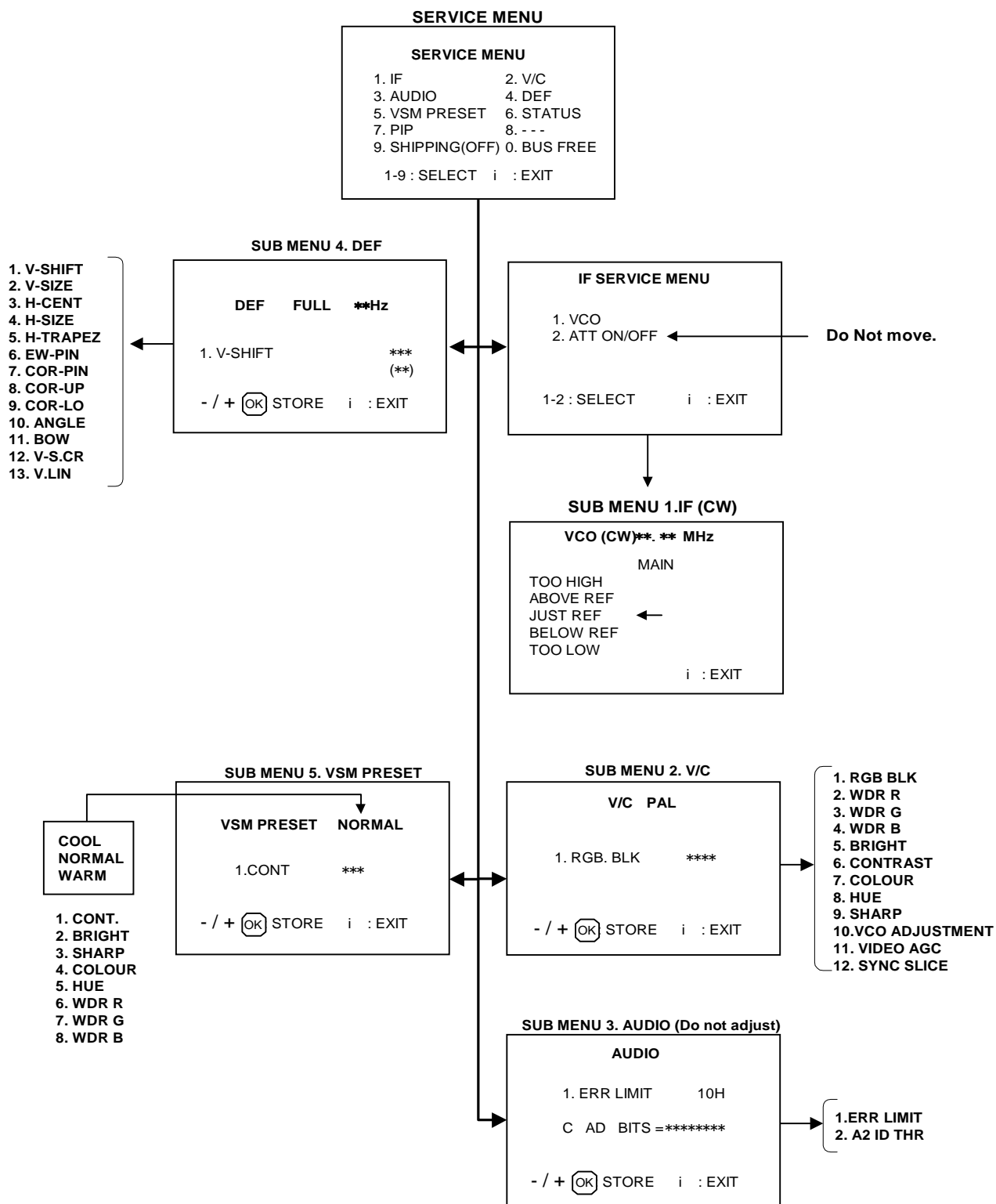

Fig. 3 SUB MENU SCREEN

AV28L2EUGR  
AV28L2EUBL  
AV28L2EUGY

(3) **Method of Setting**

● Method of Setting **1.IF**

[VCO] ..... \* It must not adjust without signal.

- ① 1 Key..... Select 1.IF.
- ② 1 Key ..... Select 1. VCO (CW)  
Check the arrow position between ABOVE REF. and BELOW REF.
- ③ INFORMATION ( **i** ) Key ..... Return to the SERVICE MENU screen.

● Method of setting **2.V/C, 3.AUDIO, 4.DEF** and **5.VSM PRESET**.

- ① 2~5 Key..... Select one from **2. V/C, 3. AUDIO, 4. DEF** and **5. VSM PRESET**.
- ② FUNCTION UP/DOWN Key ..... Select setting items.
- ③ FUNCTION +/-..... Set (adjust) the setting values of the setting items.
- ④ MENU (OK) Key ..... Memorize the setting value.  
(Before storing the setting values in memory, do not press the CH, TV, POWER ON / OFF key -  
if you do, the values will not be stored in memory.)
- ⑤ INFORMATION ( **i** ) Key ..... Return to the **SERVICE MENU** screen.

● Can not setting **6. STATUS, 7. PIP, 8. --- , 9. SHIPPING(ON) & 0. BUS FREE**.

(4) **Release of SERVICE MENU**

- 1) After completing the setting, return to the SERVICE MENU, then again press the INFORMATION (OK) key.





# ADJUSTMENT

## CHECKING ITEM

Item	Measuring instrument	Test point	Adjustment part	Description
Check of B1 Power Supply	Signal Generator  DC voltmeter  Remote Control unit	TP-91(B1) TP-E(↵) [X connector on POWER DEF PWB]	1. RGB BLK	<ol style="list-style-type: none"> <li>1. Receive any broadcast.</li> <li>2. Press the ZOOM key and select the FULL mode.</li> <li>3. Select 2. V/C from the SERVICE MENU.</li> <li>4. Select 1. RGB BLK with function UP / DOWN key.</li> <li>5. Press the function + (↵) key to find the cut off screen (Black screen).</li> <li>6. Connect a DC voltmeter to TP-91(B1) and TP-E(↵).</li> <li>7. Make sure that the voltage is DC139.9 ±2.0V.</li> <li>8. Press the function - (↵) key to return to service menu.</li> </ol>
Check of High Voltage	Signal Generator  DC voltmeter  Remote Control unit	CRT anode  Chassis GND	1. RGB BLK	<ol style="list-style-type: none"> <li>1. Receive any broadcast.</li> <li>2. Press the ZOOM key and select the FULL mode.</li> <li>3. Select 2. V/C from the SERVICE MENU.</li> <li>4. Select 1. RGB BLK with function UP / DOWN key.</li> <li>5. Press the function + (↵) key to find the cut off screen (Black screen).</li> <li>6. Connect a DC voltmeter to CRT ANODE and chassis GND.</li> <li>7. Make sure that the voltage is DC 31.0kV <sup>+1kV</sup> <sub>-1.5kV</sub>.</li> <li>8. Press the function - (↵) key to return to service menu.</li> </ol>
Check of VCO	Remote control unit		1. VCO	<ul style="list-style-type: none"> <li>● Under normal conditions, no adjustment is required.</li> <li>● Confirmation adjustment.</li> </ul> <ol style="list-style-type: none"> <li>1. Select 1.IF from the SERVICE MENU.</li> <li>2. Then select 1.VCO from the IF SERVICE MENU.</li> <li>3. Receive any broadcast.</li> <li>4. Check the arrow (←) position between the ABOVE REF. and BELOW REF.</li> </ol> <div style="border: 1px solid black; padding: 10px; margin: 10px 0;"> <p style="text-align: center;">IF SERVICE MENU</p> <p>1. VCO 2. ATT ON/OFF ← ..... (Do not move)</p> <p>1-2 : SELECT                      i : EXIT</p> </div> <div style="border: 1px solid black; padding: 10px; margin: 10px 0;"> <p style="text-align: center;">VCO(CW)                      ****MHz</p> <p style="text-align: center;">MAIN</p> <p>TOO HIGH ABOVE REF JUST REF ← BELOW REF TOO LOW</p> <p style="text-align: right;">i : EXIT</p> </div>

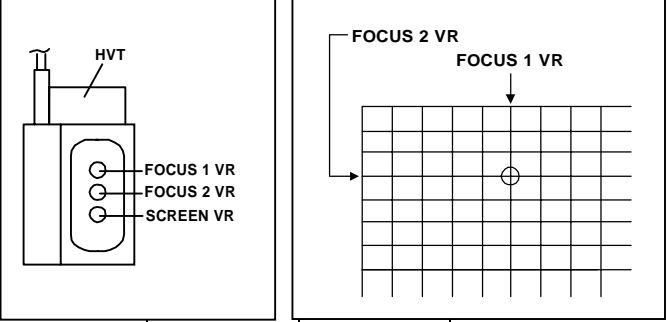
**ADJUSTMENT OF FOCUS & SCREEN**

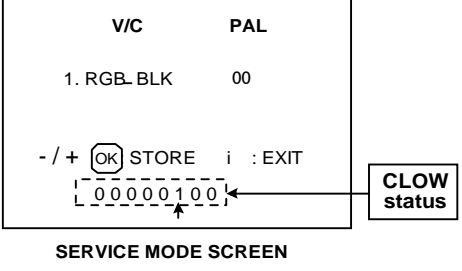
Item	Measuring instrument	Test point	Adjustment part	Description
Adjustment of FOCUS	Signal generator		FOCUS 1 VR FOCUS 2 VR [In HVT]	<ol style="list-style-type: none"> <li>1. Receive a cross-hatch signal.</li> <li>2. By turning the FOCUS 2 VR, adjust the to make the vertical lines as fine and sharp as possible.</li> <li>3. By turning the FOCUS 2 VR, adjust the picture so that the 5th vertical line from left side of the cross-hatch picture becomes thinnest.</li> <li>4. By turning the FOCUS 1 VR, adjust the 3rd horizontal line from the upper side may become uniform at the line center and its periphery.</li> <li>5. Carry out adjustment by repeating the steps 3 and 4 about.</li> <li>6. Make sure that when the screen is darkened, the lines remain in good focus.</li> </ol>
				
Adjustment of SCREEN VR	Signal generator		SCREEN VR (In HVT)	<ol style="list-style-type: none"> <li>1. Press a whole black signal .</li> <li>2. Press the ZOOM key and select the FLL mode.</li> <li>3. Select 2. V/C from the SERVICE MENU.</li> <li>4. Rotate the SCREEN VR clockwise from the full counterclockwise position and stop it at the point where "CLOW" status (marked  in Fig.) changes from 1 to 0 (which is indicated at the 3rd column from the right.)</li> </ol> <p>* "CLOW" : control loopout of window.</p>
				

**VSM PRESET SETTING**

Item	Measuring instrument	Test point	Adjustment part	Description																																				
Setting of VSM PRESET	Remote control unit		<ol style="list-style-type: none"> <li>1. CONT.</li> <li>2. BRIGHT</li> <li>3. SHARP</li> <li>4. COLOUR</li> <li>5. HUE</li> <li>6. WDR R</li> <li>7. WDR G</li> <li>8. WDR B</li> </ol>	<ol style="list-style-type: none"> <li>1. Select 5.VSM PRESET from the SERVICE MENU.</li> <li>2. Select COOL with the MENU key of the remote control unit.</li> <li>3. Adjust the FUNCTION UP/DOWN and -/+ key to bring the set values of 1.CONT.~ 8. WDR B to the values shown in the table.</li> <li>4. Press the MENU key and memorize the set value.</li> <li>5. Respectively select the VSM PRESET mode for NORMAL and WARM, and make similar adjustment as in 3 above.</li> <li>6. Press the MENU key and memorize the set value.</li> </ol> <p>* Refer to OPERATING INSTRUCTIONS for the PICTURE MODE.</p>																																				
<table border="1"> <thead> <tr> <th>VSM preset mode</th> <th>1.CONT.</th> <th>2.BRIGHT</th> <th>3.SHARP</th> <th>4.COLOUR</th> <th>5.HUE</th> <th>6.WDR R</th> <th>7.WDR G</th> <th>8.WDR B</th> </tr> </thead> <tbody> <tr> <td>COOL</td> <td>+16</td> <td>0</td> <td>-12</td> <td>0</td> <td>0</td> <td>-25</td> <td>-12</td> <td>0</td> </tr> <tr> <td>NORMAL</td> <td>0</td> <td>0</td> <td>-12</td> <td>0</td> <td>0</td> <td>0</td> <td>0</td> <td>0</td> </tr> <tr> <td>WARM</td> <td>-13</td> <td>0</td> <td>-12</td> <td>-1</td> <td>0</td> <td>+5</td> <td>0</td> <td>0</td> </tr> </tbody> </table> <p style="text-align: center;"><b>SETTING VALUES OF VSM PRESET</b></p>					VSM preset mode	1.CONT.	2.BRIGHT	3.SHARP	4.COLOUR	5.HUE	6.WDR R	7.WDR G	8.WDR B	COOL	+16	0	-12	0	0	-25	-12	0	NORMAL	0	0	-12	0	0	0	0	0	WARM	-13	0	-12	-1	0	+5	0	0
VSM preset mode	1.CONT.	2.BRIGHT	3.SHARP	4.COLOUR	5.HUE	6.WDR R	7.WDR G	8.WDR B																																
COOL	+16	0	-12	0	0	-25	-12	0																																
NORMAL	0	0	-12	0	0	0	0	0																																
WARM	-13	0	-12	-1	0	+5	0	0																																

## VIDEO/CHROMA CIRCUIT ADJUSTMENT

The setting (adjustment) using the REMOTE CONTROL UNIT is made on the basis of the initial setting values.  
The setting values which adjust the screen to the optimum condition can be different from the initial setting values.

● marked \* :Do not adjust

Colour system Setting item	Initial setting value			Colour system Setting item	Initial setting value		
	PAL	SECAM	NTSC		PAL	SECAM	NTSC
1.RGB BLK	—	—	—	7.COLOUR	000	000	000
2.WDR R	000	←	←	8.HUE	—	—	020
3.WDR G	000	←	←	9.SHARP	* +007	←	←
4.WDR B	* -012	←	←	10.VCO ADJUSTMENT	Automatically optimized after adjustment		
5.BRIGHT	000	←	←	11.VIDEO AGC	* 000	←	←
6.CONTRAST	000	←	←	12.SYNC SLICE	* +007	←	←

Item	Measuring instrument	Test point	Adjustment part	Description
Adjustment of WHITE BALANCE (High-Light)	Signal generator  Remote control unit		2.WDR R 3.WDR G	<ul style="list-style-type: none"> <li>● Set the PICTURE MODE to NORMAL.</li> <li>1. Receive a black and white signal (colour off).</li> <li>2. Select 2. V/C from the SERVICE MENU.</li> <li>3. Modify 2. WDR R and 3.WDR G data to adjust the white balance ( high light ).</li> <li>4. Press the MENU key and memorize the set value.</li> <li>5. Change the contrast and brightness with the remote control up &amp; down from low–light to high–light and check that the tracking of the white balance is good.</li> </ul>
Adjustment of SUB BRIGHT	Remote control unit		5.BRIGHT	<ol style="list-style-type: none"> <li>1. Receive any broadcast.</li> <li>2. Select 2.V/C from the SERVICE MENU.</li> <li>3. Select 5.BRIGHT with the FUNCTION UP/DOWN key.</li> <li>4. Set the initial setting value with the FUNCTION -/+ key.</li> <li>5. If the brightness is not the best with the initial setting value, make fine adjustment until you get the best brightness.</li> <li>6. Press the MENU key and memorize the set value.</li> </ol>
Adjustment Of SUB CONTRAST.	Remote control unit		6.CONTRAST	<ol style="list-style-type: none"> <li>1. Receive any broadcast.</li> <li>2. Select 2.V/C from the SERVICE MENU.</li> <li>3. Select 6.CONTRAST with the FUNCTION UP/DOWN key.</li> <li>4. Set the initial setting value with the FUNCTION - or + key.</li> <li>5. If the contrast is not the best with the initial setting value, make fine adjustment until you get the best contrast.</li> <li>6. Press the MENU key and memorize the set value.</li> </ol>

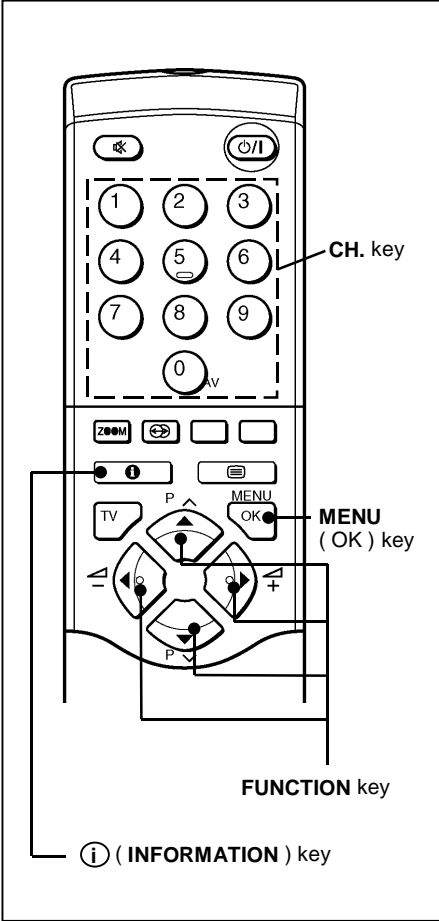
Item	Measuring instrument	Test point	Adjustment part	Description
Adjustment of SUB COLOUR I  	Remote control unit		7.COLOUR (PAL/SECAM/NTSC)	<b>[Method of adjustment without measuring instrument]</b>
			PAL COLOUR	(PAL COLOUR) 1. Receive PAL broadcast. 2. Select 2.V/C from the SERVICE MENU. 3. Select 7.COLOUR with the FUNCTION UP/DOWN key. 4. Set the initial setting value for PAL COLOUR with the FUNCTION - or + key. 5. If the colour is not the best with the initial set value, make fine adjustment until you get the best colour. 6. Press the MENU key and memorize the set value.
			SECAM COLOUR	(SECAM COLOUR) 1. Receive a SECAM broadcast. 2. Make fine adjustment of SECAM COLOUR in the same manner as for above.
			NTSC COLOUR	(NTSC 3.58 COLOUR) 1. Input a NTSC 3.58MHz COMPOSITE VIDEO signal from the EXT terminal. 2. Make similar fine adjustment of NTSC 3.58 COLOUR in the same manner as for above.
				(NTSC 4.43 COLOUR) 1. Receive a NTSC 4.43MHz COMPOSITE VIDEO signal from the EXT terminal. 2. Make similar fine adjustment of 4.43 COLOUR in the same manner as for above.

Item	Measuring instrument	Test point	Adjustment part	Description
Adjustment of SUB COLOUR II	Signal generator  Oscilloscope  Remote control unit	TP-47B TP-E(↵) [CRT SOCKET PWB]	7.COLOUR (PAL/SECAM/NTSC)	<b>[Method of adjustment using measuring instrument]</b>
			PAL COLOUR	(PAL COLOUR)  1. Receive a PAL full field colour bar signal(75% white). 2. Select 2.V/C from the SERVICE MENU. 3. Select 7.COLOUR with the FUNCTION UP/DOWN key. 4. Set the initial setting value of PAL COLOUR with the FUNCTION - or + key. 5. Connect the oscilloscope between TP-47B and TP-E 6. Adjust PAL COLOUR and bring the value of (A) in the illustration to <b>+5V</b> (voltage difference between white (w) and blue (B)). 7. Press the MENU key and memorize the setting value.
			SECAM COLOUR	(SECAM COLOUR)  1. Receive a SECAM full field colour bar signal(75% white). 2. Set the initial setting value of SECAM COLOUR with the FUNCTION -/+ key. 3. Adjust SECAM COLOUR and bring the value of (A) of the illustration to <b>+4V</b> (W~B). 4. Press the MENU key and memorize the setting value.
			NTSC COLOUR	(NTSC 3.58 COLOUR)  1. Input a NTSC 3.58MHz COMPOSITE VIDEO signal (full field colour bar with 75% white) from the EXT terminal. 2. Set the initial setting value of NTSC 3.58 COLOUR with the FUNCTION -/+ key. 3. Adjust NTSC 3.58 COLOUR and bring the value of (A) of the illustration to <b>+6V</b> (W~B). 4. Press the MENU key and memorize the setting value.
				(NTSC 4.43 COLOUR)  1. Input a NTSC 4.43MHz COMPOSITE VIDEO signal (full field colour bar with 75% white) from the EXT terminal. 2. Set the initial setting value of NTSC 4.43 COLOUR with the FUNCTION -/+ key. 3. Adjust NTSC 4.43 COLOUR and bring the value of (A) of the illustration to <b>+6V</b> (W~B). 4. Press the MENU key and memorize the setting value.

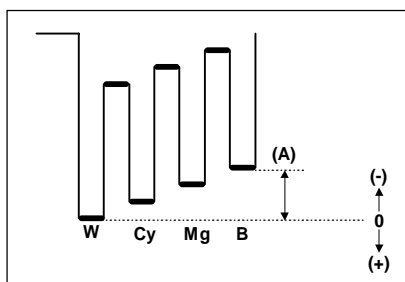

Item	Measuring instrument	Test point	Adjustment part	Description
Adjustment of SUB HUE I	Remote control unit		8.HUE	<b>[Method of adjustment without measuring instrument]</b>
			NTSC 3.58 HUE	[NTSC 3.58 HUE] .....(NTSC only) 1. Input a NTSC 3.58MHz COMPOSITE VIDEO signal (full field colour bar with 75% white) from the EXT terminal. 2. Select 2.V/C from the SERVICE MENU. 3. Select 8.HUE with the FUNCTION UP/DOWN key. 4. Set the initial setting value of NTSC 3.58 HUE with the FUNCTION +/- key. 5. If you cannot get the best hue with the initial setting value, make fine adjustment until you get the best hue. 6. Press the MENU key and memorize the set value.
			NTSC 4.43 HUE	[NTSC 4.43 HUE] 1. When NTSC 3.58 is set, NTSC 4.43 will be automatically set at the respective values.
Adjustment of SUB HUE II	Signal generator  Oscilloscope  Remote control unit	TP-47B TP-E(↕) [CRT SOCKET PWB]	8.HUE	<b>[Method of adjustment using measuring instrument]</b>
			NTSC 3.58 HUE	[NTSC 3.58 HUE] 1. Input a NTSC 3.58MHz COMPOSITE VIDEO signal (full field colour bar with 75% white) from the EXT terminal. 2. Select 2.V/C from the SERVICE MENU. 3. Select 8.HUE with the FUNCTION UP/DOWN key. 4. Set the initial setting value of NTSC 3.58 HUE with the FUNCTION - or + key. 5. Connect the oscilloscope between TP-47B and TP-E 6. Adjust NTSC 3.58 HUE to bring the value of <b>(B)</b> in the illustration to <b>-3V</b> (voltage difference between white (W) and magenta(Mg)). 7. Press the MENU key and memorize the setting value
			NTSC 4.43 HUE	[NTSC 4.43 HUE] 1. When NTSC 3.58 is set, NTSC 4.43 will be automatically set at the respective values.
Adjustment of VCO for colour decoder	Signal generator  Remote control unit		10. VCO	1. Input a PAL full field colour bar signal (75% white) from the EXT terminal. 2. Select 2. V/C from the SERVICE MENU. 3. Select 10. VCO adjustment with the FUNCTION UP/DOWN key. 4. Press the OK key then automatically optimized.

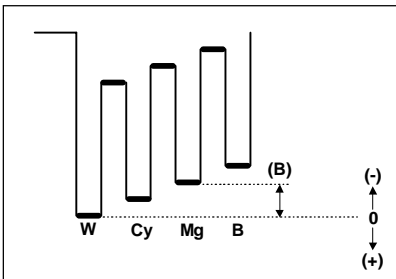

## DEFLECTION CIRCUIT ADJUSTMENT

There are 4 aspect modes ( ①FULL, ②PANORAMIC, ③SUBTITLE, ④COMPRESS) of the adjustment ( 1 ) 100Hz i mode, ( 2 ) 60Hz p and ( 3 ) 120Hz i mode..... depending upon the kind of signals ( vertical frequency 100Hz i / 60Hz p / 120Hz i ).

- When the 100Hz FULL mode has been established, the setting of other modes will be done automatically. However, if the picture quality has not been optimized, adjust each mode again, respectively.
- The adjustment using the remote control unit is made on the basis of the initial setting values.
- The setting values which adjust the screen to the optimum condition can be different from the initial setting values.

Setting item	Initial setting value							
	FULL		PANORAMIC		SUBTITLE		COMPRESS	
	100Hz i	60Hz p	100Hz i	60Hz p	100Hz i	60Hz p	100Hz i	120Hz i
1.V- SHIFT	-4	+8	+1	0	+8	+2	0	0
2.V-SIZE	+7	0	0	0	0	0	-15	0
3.H-CENT	-23	+4	-4	0	0	0	0	0
4.H-SIZE	-27	-4	-4	0	0	0	0	0
5.TRAPEZ	-17	+13	0	0	0	0	0	0
6.EW-PIN	-45	0	0	0	0	0	0	0
7.COR-PIN	0	0	0	0	0	0	0	0
8.COR-UP	0	0	0	0	0	0	0	0
9.COR-LO	-10	0	0	0	0	0	0	0
10.ANGLE	0	0	0	0	0	0	0	0
11.BOW	0	0	0	0	0	0	0	0
12.V-S.CR	+6	0	+5	0	+7	0	0	0
13.V-LIN	-4	+4	-11	0	-22	0	0	0

\* Screen tone : Do not move fixed value.

Item	Measuring instrument	Test point	Adjustment part	Description												
<b>Adjustment of V-SHIFT</b>	Signal generator  Remote control unit		<b>1.V- SHIFT</b>	<p>[FULL mode]</p> <ol style="list-style-type: none"> <li>1. Receive a circle pattern signal of vertical frequency 50Hz.</li> <li>2. Select 4.DEF from the SERVICE MENU.</li> <li>3. Select 1.V-SHIFT with the FUNCTION UP/DOWN key.</li> <li>4. Adjust V-SHIFT to make <b>A = B</b>.</li> <li>5. Check the adjustment value above in other zoom mode. If it is a wrong adjustment, re-adjust in "PANORAMIC" mode and adjust by 1. V-SHIFT.</li> <li>6. Press the MENU key and memorize the set value.</li> </ol>												
<b>Adjustment of V-SIZE</b>			<b>2.V-SIZE</b>	<ol style="list-style-type: none"> <li>7. Receive a cross-hatch signal.</li> <li>8. Select 2.V-SIZE and set the initial setting value.</li> <li>9. Adjust V-SIZE and make sure that the vertical screen size of the picture size is in the bellow table.</li> <li>10. Press the MENU key and memorize the set value.</li> <li>11. Input a NTSC VIDEO signal (60Hz) from the EXT terminal, and make sure that the vertical screen size is in the table below.</li> <li>12. Press the MENU key and memorize the set value.</li> </ol>												
<table border="1"> <thead> <tr> <th data-bbox="102 1599 320 1688">ASPECT SCREEN POSITION</th> <th data-bbox="325 1599 512 1688">FULL</th> <th data-bbox="517 1599 687 1688">PANORAMIC</th> <th data-bbox="692 1599 863 1688">SUB TITLE</th> </tr> </thead> <tbody> <tr> <td data-bbox="102 1695 320 1771">TOP</td> <td data-bbox="325 1695 512 1771">92%</td> <td data-bbox="517 1695 687 1771">87%</td> <td data-bbox="692 1695 863 1771">70%</td> </tr> <tr> <td data-bbox="102 1778 320 1854">BOTTOM</td> <td data-bbox="325 1778 512 1854">92%</td> <td data-bbox="517 1778 687 1854">87%</td> <td data-bbox="692 1778 863 1854">83%</td> </tr> </tbody> </table>					ASPECT SCREEN POSITION	FULL	PANORAMIC	SUB TITLE	TOP	92%	87%	70%	BOTTOM	92%	87%	83%
ASPECT SCREEN POSITION	FULL	PANORAMIC	SUB TITLE													
TOP	92%	87%	70%													
BOTTOM	92%	87%	83%													
<b>[ SCREEN SIZE ]</b>																

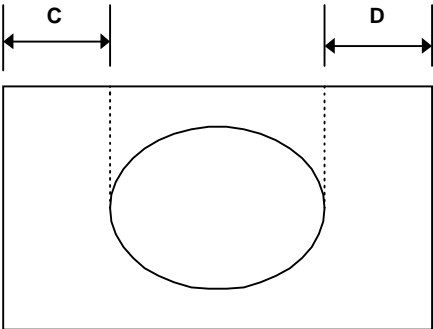
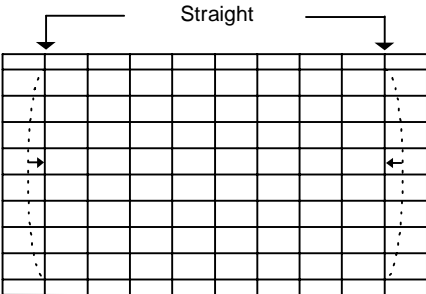

Item	Measuring instrument	Test point	Adjustment part	Description								
Adjustment of H.CENTER	Signal generator Remote control unit		3.H-CENT.	13. Receive a circle pattern signal. 14. Select 3.H-CENT and set the initial setting value. 15. Adjust H-CENT to make $C=D$ . 16. Press the MENU key and memorize the set value.								
<div style="text-align: center;">  </div>												
Adjustment of H.SIZE			4.H-SIZE	17. Receive a cross-hatch signal. 18. Select 4.H-SIZE and set the initial setting value. 19. Adjust H-SIZE and make sure that the horizontal screen size of the picture size is in the bellow table. 20. Press the MENU key and memorize the set value. 21. Input a NTSC VIDEO signal (60Hz) from the EXT terminal, and make sure that the horizontal screen size is in the table below. 22. Press the MENU key and memorize the set value.								
<table border="1" style="margin-left: auto; margin-right: auto;"> <thead> <tr> <th>ASPECT MODE</th> <th>FULL</th> <th>PANORAMIC</th> <th>SUBTITLE</th> </tr> </thead> <tbody> <tr> <td>H SIZE</td> <td>92%</td> <td>95%</td> <td>92%</td> </tr> </tbody> </table> <p style="text-align: center;">[ SCREEN SIZE ]</p>					ASPECT MODE	FULL	PANORAMIC	SUBTITLE	H SIZE	92%	95%	92%
ASPECT MODE	FULL	PANORAMIC	SUBTITLE									
H SIZE	92%	95%	92%									
Adjustment of EW-PIN			6.EW-PIN	23. Select 6.EW-PIN and set the initial setting value 24. Adjust EW-PIN and make the 2nd.vertical lines at the left and right edges of the screen straight. Also make sure that the 3rd vertical lines are straight. 25. Press the MENU key and memorize the set value.								
<div style="text-align: center;">  </div>												

Item	Measuring instrument	Test point	Adjustment part	Description
<b>Adjustment of TRAPEZ</b>	Signal generator Remote control unit		<b>5.TRAPEZ</b>	26. Receive a cross-hatch signal. 27. Select 5.TRAPEZ with the FUNCTION UP/DOWN key. 28. Set the initial setting value of TRAPEZ with the FUNCTION - or + key. 29. Adjust TRAPEZ and bring the VERTICAL lines at the right and left edges of the screen parallel . 30. Press the MENU key and memorize the set value.
<b>Adjustment of CORNER UP/ LOW</b>	Signal generator Remote control unit		<b>7.COR-PIN</b> <b>8.COR-UP</b> <b>9.COR-LO</b>	31. Select 9.COR-LO with the FUNCTION UP / DOWN key. 32. Set the initial setting value of COR-LO with the FUNCTION - or + key. 33. Adjust COR-LO, and bring the straight line at the low corner. 34. Select 8.COR-UP with the FUNCTION UP / DOWN key. 35. Set the initial setting value of COR-UP with the FUNCTION - or + key. 36. Adjust COR-UP, and bring the straight line at the upper corner. 37. If the extreme upper & lower corners and a little pin or barrel, chose 7.COR-PIN and adjust. And adjust to get the straight. Store the set value.
<b>Adjustment of ANGLE</b>	Signal generator Remote control unit		<b>10.ANGLE</b>	<ul style="list-style-type: none"> <li>In case where there is a parallelogrammatical distortion of images on the screen. (Fig. A)</li> </ul> 38. Select 10.ANGLE with the FUNCTION UP / DOWN key. 39. Adjust ANGLE, and bring the VERTICAL lines straight. 40. Press the MENU key and memorize the set value.

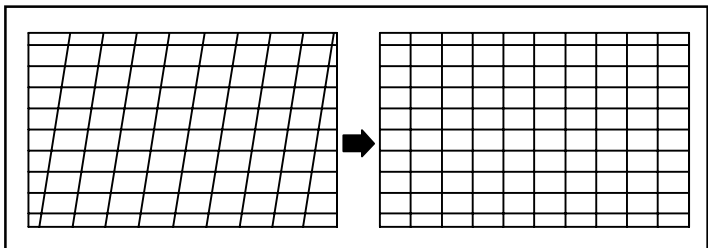
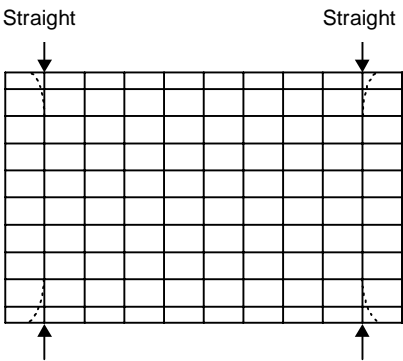
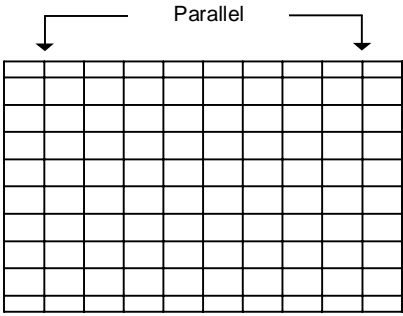

Fig. A

Item	Measuring instrument	Test point	Adjustment part	Description
Adjustment of BOW	Signal generator Remote control unit		11.BOW	<ul style="list-style-type: none"> <li>In case where there is a bow-shaped distortion of images on the screen. (Fig.C)</li> </ul> 41. Select 11.BOW with the FUNCTION UP/DOWN key. 42. Adjust BOW, and bring the VERTICAL lines straight. 43. Press the MENU key and memorize the set value.
Fig. C				
Adjustment of V-S.CR & V.LINE			12.V-S.CR 13.V.LIN.	<ul style="list-style-type: none"> <li>When the vertical linearity has been deteriorated remarkably, perform the following steps.</li> </ul> 44. Receive a cross-hatch signal. 45. Select 13. V.LIN with the FUNCTION UP / DOWN key. 46. Set the initial setting value of 13. V.LIN with the FUNCTION - / + key. 47. Select 12. V-S.CR. with the FUNCTION UP / DOWN key. 48. Set the initial setting value of 12. V-S.CR. with the FUNCTION - / + key. 49. Adjust 13. V.LIN and 12. V-S.CR. so that the spaces of each line on TOP, CENTER, and BOTTOM become uniform.
NOTE : Do not adjust "PANORAMIC" & "SUBTITLE" mode.				
				At first the adjustment in 100Hz FULL mode should be done, then the data for the other aspect mode is corrected in the respective value at the same time. And confirm the deflection adjustment initial setting value in 120Hz (NTSC EXT mode) FULL mode. If the adjustment in 100Hz each aspect mode has been done and stored, the data for the same aspect modes in 120Hz is corrected in the respective value. Only the data for the other aspect mode in 120Hz is corrected for itself.

AV28L2EUGR  
AV28L2EUBL  
AV28L2EUGY

### AUDIO CIRCUIT ADJUSTMENT

- Do not touch 3. **AUDIO** adjustment of the SERVICE MENU as it requires no adjustment.  
If values had changed for the some reason, set the initial values in the following table.

#### 3. **AUDIO**(Do not adjust)

Setting item	Variable range	fixed value
1. ERR LIMIT	00H~FFH	10H
2. A2 ID THR	00H~FFH	19H

## REPLACEMENT OF CHIP COMPONENT

### ■ CAUTIONS

1. Avoid heating for more than 3 seconds.
2. Do not rub the electrodes and the resist parts of the pattern.
3. When removing a chip part, melt the solder adequately.
4. Do not reuse a chip part after removing it.

### ■ SOLDERING IRON

1. Use a high insulation soldering iron with a thin pointed end of it.
2. A 30w soldering iron is recommended for easily removing parts.

### ■ REPLACEMENT STEPS

#### 1. How to remove Chip parts

##### ◆ Resistors, capacitors, etc

- (1) As shown in the figure, push the part with tweezers and alternately melt the solder at each end.

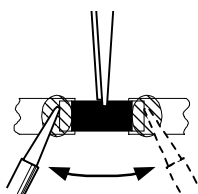

- (2) Shift with tweezers and remove the chip part.

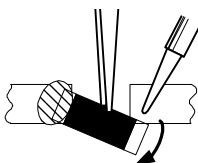

##### ◆ Transistors, diodes, variable resistors, etc

- (1) Apply extra solder to each lead.

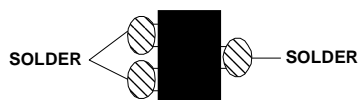

- (2) As shown in the figure, push the part with tweezers and alternately melt the solder at each lead. Shift and remove the chip part.

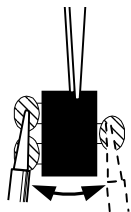

Note : After removing the part, remove remaining solder from the pattern.

#### 2. How to install Chip parts

##### ◆ Resistors, capacitors, etc

- (1) Apply solder to the pattern as indicated in the figure.

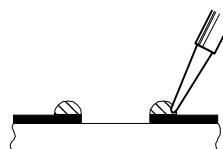

- (2) Grasp the chip part with tweezers and place it on the solder. Then heat and melt the solder at both ends of the chip part.

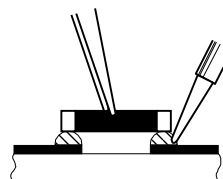

##### ◆ Transistors, diodes, variable resistors, etc

- (1) Apply solder to the pattern as indicated in the figure.
- (2) Grasp the chip part with tweezers and place it on the solder.
- (3) First solder lead **A** as indicated in the figure.

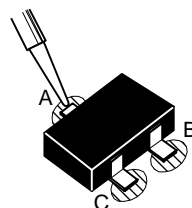

- (4) Then solder leads **B** and **C**.

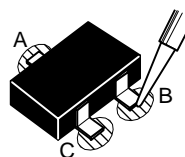

AV28L2EUGR  
AV28L2EUBL  
AV28L2EUGY

AV28L2EUGR  
AV28L2EUBL  
AV28L2EUGY

**JVC**

VICTOR COMPANY OF JAPAN, LIMITED

HOME AV NETWORK BUSINESS UNIT 12, 3-chome, Moriya-cho, Knagawa-ku, Yokohama, Kanagawa-prefecture, 221-8528, Japan

AV28L2EUGR-U #4  
AV28L2EUBL-U #3  
AV28L2EUGY-U #3



Printed in Japan  
VP 0105  
DP105851